

Technaxx[®]

FMT600BT Transmitter

User Manual

**Transfer of music and calls directly from your Bluetooth device
to your car radio**

This device complies with the requirements of the standards referred to the Directive **R&TTE 1999/5/EC**.
The Declaration of Conformity you find here: www.technaxx.de/ (in bar at the bottom
"Konformitätserklärung"). Before using the device the first time, read the user manual carefully.

Turn OFF nearby Bluetooth devices to avoid signal interference!

Service phone No. for technical support: 01805 012643 (14 cent/minute from German fixed-line
and 42 cent/minute from mobile networks). Free Email: support@technaxx.de

Features

- Wirelessly transmit phone calls from Bluetooth mobile phones to the car FM stereo system, for every car type without modification
- Take convenient phone calls and still drive safely and transmit wirelessly your MP3 music to the car radio via UKW
- Built-in Microphone for hands-free handling (switches to hands-free mode automatically from music playing status when receiving calls)
- USB port for charging a mobile device, e.g. iPad (Output 5V/2.1A)
- USB port to plug in an USB flash drive (up to 32GB) with MP3 music tracks
- Bluetooth chip is compatible with a wide range of Bluetooth enabled devices (= Pairing)
- Last saved UKW frequency stays saved
- Streaming music in MP3/WMA format from a USB flash drive
- 3.5mm AUX jack: music playback from external audio devices (iPod, MP3 player, etc.)
- Remote control (included) for more convenient operation
- "Voice prompts" (means: spoken announcement)
- Easy handling and installation (just plug it into the 12V/24V socket of a vehicle)

Technical Specifications

Bluetooth module / BT version	CSR BC8635 / Bluetooth version 4.0
Bluetooth operating distance	max. 10m
LCD display size	20 x 25.5 mm (1.1")
Frequency range	87.6 – 107.9 MHz, max. 3m
Frequency stability	±10ppm
Audio input	3.5mm stereo jack
Music format	MP3, WMA
Memory	USB up to 32GB
FM transmitter input	DC 12V – 24V
Charger output	5V / 2.1A
Weight / Dimensions	45 g / (L) 7,5 x (W) 3,4 x (H) 10,5 cm
Package Contents	FMT600BT Transmitter, AUX-IN cable, Remote control, User Manual

View of device

AUX-IN port
SD Card Slot
Volume + / Volume -
USB Reader
Previous button / Next button
Frequency modulation "M"
Output 5V / 2.1 A
Answer / Hang off Play / Pause

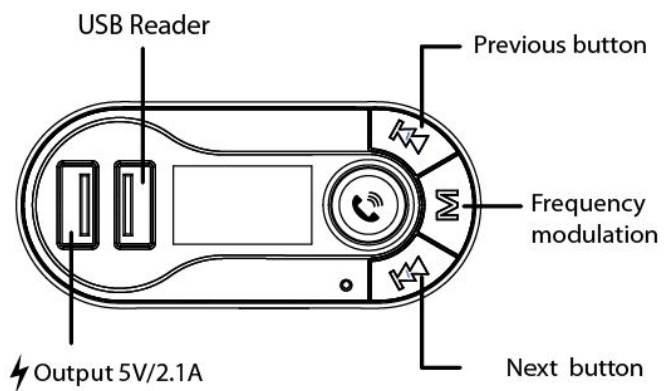
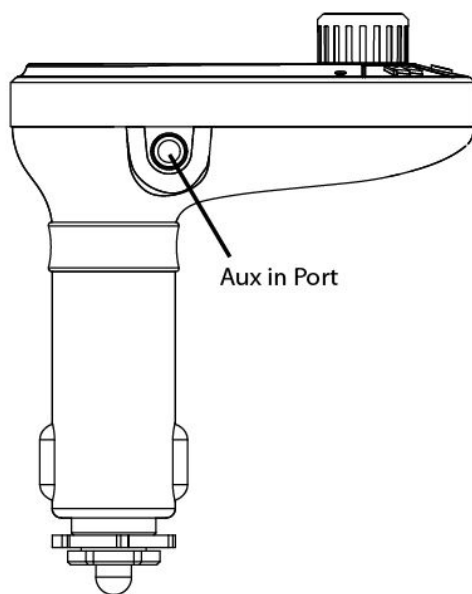

Using FM Transmitter function



- (a) Plug the FM transmitter into the cigarette lighter port or power port of your vehicle.
- (b) First tune your radio to a free FM frequency, then match the same frequency to the FM transmitter.
- (c) Insert a USB flash drive, which contains MP3 files, into the USB port. It will play and transmit the MP3 files automatically. **Attention:** only the inward USB Port can serve as a USB Reader!
- (d) **Line-IN function:** Use the provided audio cable to connect a MP3/MP4 player or another external device to the AUX-IN port of this FM transmitter. When using this function, you have to stop playback from the USB flash drive, and **all functions** will be controlled by the external device.

Using Bluetooth function

Using Bluetooth for the first time, you need to pair your mobile device with this FM transmitter.

- (a) Activate the Bluetooth function on your mobile device. Then search the NEW device. When the mobile device has detected this FM transmitter with the name "**TECHNAXX**", pair the devices by using the original password "**0000**".
- (b) In the music playback mode this FM transmitter will automatically switch to the telephone mode, when there is an incoming call.

Bluetooth calling

Answer the incoming call	Press the blue  knob
Hang off a call	Press the blue  knob
Dial the last number	Press 2x the blue  knob

When making a call, you can only dial the phone number by your mobile phone, but once the call is connected, you can use the hands-free function.

Using USB charger function

When this FM transmitter is powered from car lighter socket, connect the USB output port 5V/2.1A of this FM transmitter to your mobile device with a special USB cable** (**not included). This FM transmitter can be used as charger for mobile devices. **ATTENTION:** The USB output port with 5V/2.1A is for charging an external device (e.g. iPad).

Get access to Menu Lists

(a) “Play” mode

While music is playing, press the “M” button for more then 3 seconds to see this menu:

Language	select the language you prefer
Contrast	change the contrast of the display
Firmware version	see the firmware version of the FM transmitter
Tx-Power	change the transmission power depending on the region (Europe, ROW)
Exit	select to finish the configuration

(b) “Pause” mode:

Music will pause when you press the  button. Then press the “M” button for more then 3 seconds to see this menu list:

U-disk Dir	select the file to play
Delete file	select the file to delete
Delete all	select to delete all the file
Language	select the language you prefer
Contrast	change the contrast of the display
Firmware version	see the firmware version of the FM transmitter
Exit	select to finish the configuration

ATTENTION (see remote control)

(a) Conversion between regional configurations

This product also supports various regional configurations. Press the “M” button for more then 3 seconds till the menu appears. Choose “Tx-Power” and then press the “M” button on the FM transmitter to choose “Europe” (in Europe) or “ROW” (in the rest of the world). Then press the “M” button on the FM transmitter to confirm. [The sound quality under “ROW” is better than under “Europe” mode.]

(b) Conversion from Bluetooth to USB flash drive

When the FM transmitter is playing the music from your mobile phone via Bluetooth, press the “Pause” button on the FM transmitter. After ~ 10 seconds it appears on the screen the following: “Press M key”. Then press the “M” button. The FM transmitter then will play the music from USB flash drive.







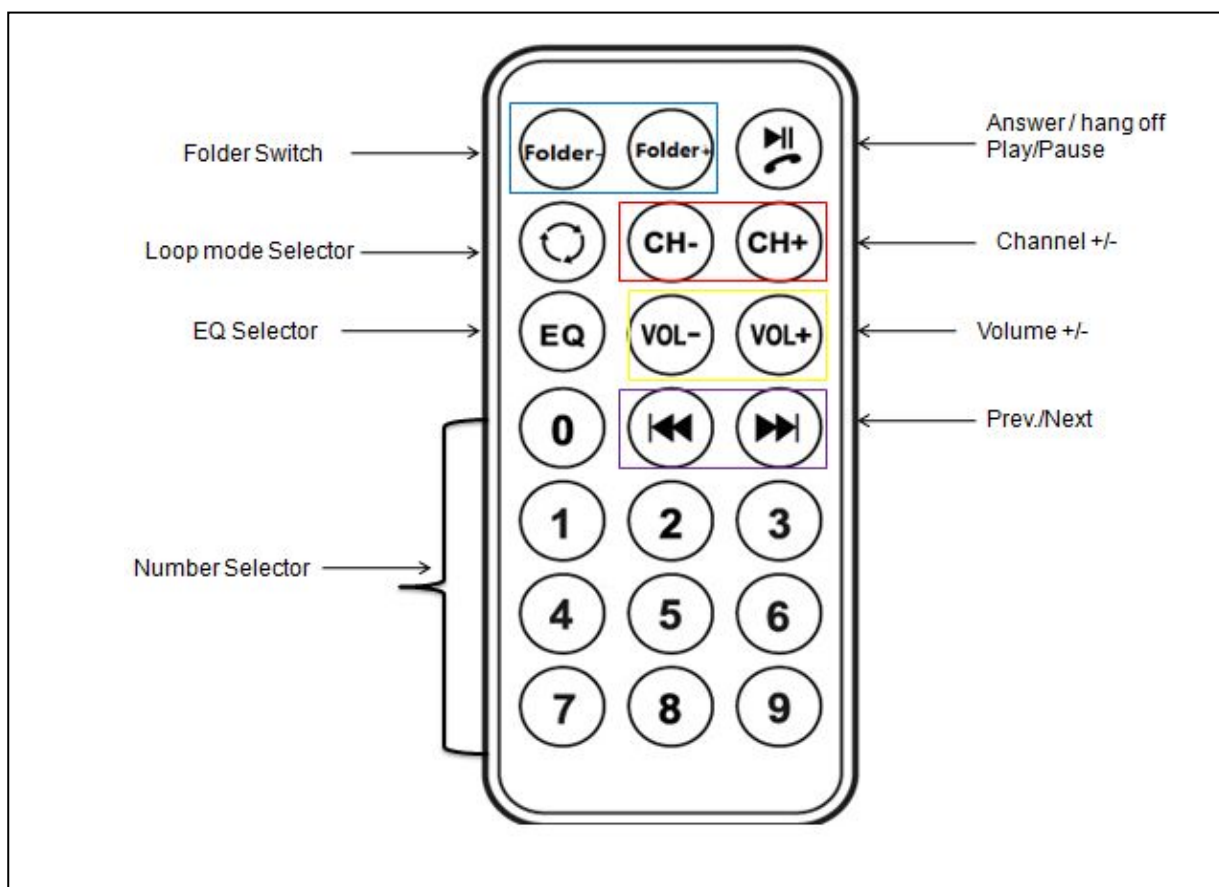





View of remote control









Most of the function can be fulfilled by the remote control.

Folder Switch
Loop mode Selector
EQ Selector
Number Selector
Answer / Hang off Play / Pause
Channel + / -
Volume + / -
Prev. / Next (Previous Song / Next Song)



Quick Using Guide

Operation Guide	FM transmitter	Remote Control
Answer / Hang up a call	Press  button to answer a call Press  button to hang off a call	Press  button
Play music / Pause music	Press  button to play music Press  button again to pause music playback	Press  button
Increase the volume	Rotate clockwise to increase the volume.	Press VOL+ to increase the Volume.
Decrease the volume	Rotate anticlockwise to decrease the volume.	Press VOL- to decrease the volume.
Set Frequency	Press "M" button first. Then press  to increase the frequency. Press  to decrease the frequency.	Press CH+ button to increase by 0.1MHz. Press CH- button to decrease by 0.1MHz Or press the numbers of the frequency what you desired, then press CH+ button to confirm.
Choose Music	Press  to play the next song. Press  to play the previous song.	Press  to play the next song. Press  to play the previous song. Or press the number of the song and then press  to confirm.

Choose EQ	Support by remote control only	Press EQ button to choose your favorite EQ.
Change Loop Mode	Support by remote control only	Press  button to change to loop mode.
Change Language	Press “M” button for more than 3 seconds first. Then choose “Language” option by pressing  and  . Short press “Language” to choose the desired language by pressing  and  . Then press “M” to confirm.	Support by FM transmitter only
Change Contrast	Press “M” button for more than 3 seconds first. Then choose “Contrast” option by pressing  and  . Short press “Contrast” to choose a contrast setting by pressing  and  . Then press “M” to confirm.	Support by FM transmitter only
Switch Folder	Press “M” button under PAUSE MODE for more than 3 seconds first. Then choose “USB-disk Dir” or “Card Folder” and press “M” button to confirm. Choose your desired folder and then press “M” button to confirm this folder.	Press Folder+ or Folder- switch the folder.

How to solve problems

The FM transmitter does not start: Check the fuse first. Exact handling see at the beginning of the user manual (How to replace the fuse).

The fuse thread is blown: The fuse has to be exchanged by an equal fuse. Exact handling see at the beginning of the user manual (How to replace the fuse).

The device does not switches on again: Check the function of the cigarette lighter.

The cigarette lighter has no function: Contact your car garage.

Problem when operating: First switch off the FM transmitter and then switch it on again.

Warnings

- Do not attempt to disassemble the device, it may result in short-circuit or even damage.
- Do not drop or shake the device, it may break internal circuit boards or mechanics.
- Keep the device in dry and ventilated environment. Avoid high humidity and high temperature. Also batteries should not be exposed to excessive heat or direct sunlight.
- Keep the surface of the device clean, but do not use organic solvents.
- Keep the device away from little children.

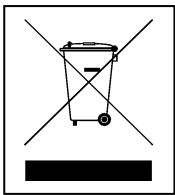

Hints for Environment Protection: Packages materials are raw materials and can be recycled. Do not disposal old devices or batteries into the domestic waste. **Cleaning:** Protect the device from contamination and pollution (use a clean drapery). Avoid using rough, coarse-grained materials or solvents/aggressive cleaner. Wipe the cleaned device accurately. **Important Notice:** Should battery fluid leak from a battery, wipe the battery case with a soft cloth dry. **Distributor:** Technaxx Deutschland GmbH & Co.KG, Kruppstr. 105, 60388 Frankfurt a.M., Germany